

Spider  Farmer

USER MANUAL

SE SERIES

Push The Limits Of Productivity

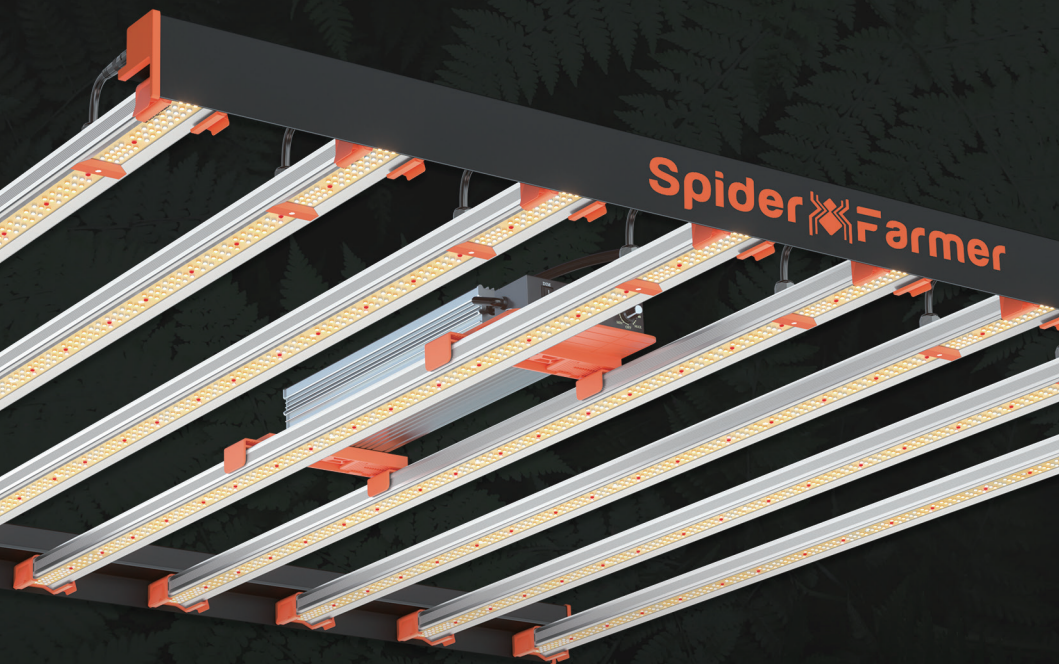

SF-SE-02

WHY CHOOSE SPIDER FARMER?



Well-established business:

We are partners with Samsung



Shipping ability:

A. Global delivery supported

B. We have warehouses in The USA,CA,AU,UK,EU,RU,TH
(We offer delivery within 24 hours)



Customer Service :

A. Local repair centers in The USA,CA,AU,UK,EU,RU

B. 5 Year warranty

C. Considerate customer service department



Professional technology support is available, including:
PPFD test data, hanging height recommendations etc



Bulk price discounts:

The larger the order the cheaper the price



MANUAL INDEX

SE3000 Specifications	01
SE4500 Specifications	02
SE5000 Specifications	03
SE7000 Specifications	04
SE8600 Specifications	05
SE1000W Specifications	06
Package Includes	07
Installation	08 - 09
User tips	10
Dimming Operation	11
Warranty	12
Other Categories	13
Other Languages	14-18

FULL SPECTRUM

SE3000 300W

LED GROW LIGHT

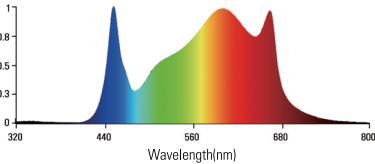

Height: 8"

448	803	776	772	800	446
698	1368	1264	1267	1360	702
667	1337	1204	1203	1339	664
666	1336	1210	1206	1340	665
697	1364	1269	1265	1370	701
449	797	779	777	801	447

0.0 0.5 1.0 1.5 2.0 2.5 3(Ft)

Height: 10"

479	752	774	777	756	494
691	1184	1196	1192	1189	689
742	1187	1199	1196	1182	740
744	1183	1197	1195	1184	743
693	1182	1195	1193	1187	690
492	755	776	779	758	487

0.0 0.5 1.0 1.5 2.0 2.5 3(Ft)

Specifications

Spectrum: 660-665nm,2800-3200K,4800-5000K

LED: SAMSUNG LM301B

PPF : 823umol/S

Operating Temperature: -20-35 C

Power Draw: 300W±5%@AC120-277V

Lifespan: 100000H

PPE: 2.75umol/J

Light Dimensions: 24.02"x24.02"x2.95"

Commercial Coverage: 2x2 FT

Personal Coverage: 3x3 FT

Input Voltage: AC100-277V

2.75 Efficacy
umol/j



5 Warranty
Years

FULL SPECTRUM

SE4500 430W

LED GROW LIGHT

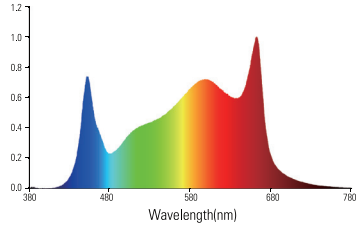
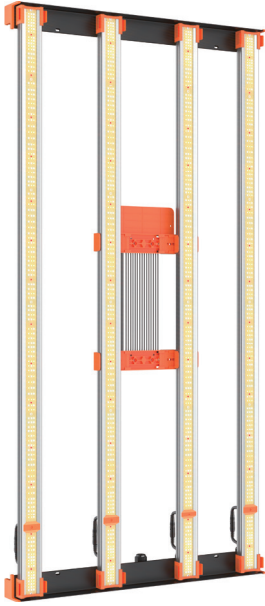

Height: 8"

1240	1401	1436	1451	1448	1434	1399	1239
1243	1392	1451	1457	1452	1450	1391	1245
1248	1389	1448	1449	1455	1445	1396	1250
1238	1402	1437	1450	1443	1432	1404	1237

0.0 0.5 1.0 1.5 2.0 2.5 3.0 3.5 4(Ft)

Height: 10"

1141	1295	1350	1370	1367	1348	1293	1140
1147	1318	1383	1399	1394	1382	1317	1149
1152	1315	1380	1391	1397	1377	1322	1154
1139	1296	1351	1369	1362	1346	1298	1138

0.0 0.5 1.0 1.5 2.0 2.5 3.0 3.5 4(Ft)

Specifications

Spectrum: 660-665nm,2800-3200K,4800-5000K

LED: SAMSUNG LM301B

PPF: 1208umol/S

PPE: 2.8umol/J

Commercial Coverag: 4x2 FT

Personal Coverage: 5x3 FT

Light Dimensions: 45.31"x22.83"x3.42"

Input Voltage: AC100-277V

Operating Temperature: -20-35 C

Power Draw: 430W±5%@AC120-277V

Lifespan: 100000H

2.8
umol/j Efficacy



5
Years Warranty

FULL SPECTRUM

SE5000 480W

LED GROW LIGHT

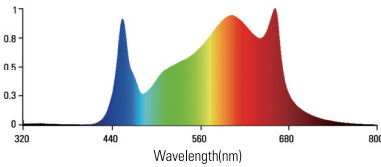
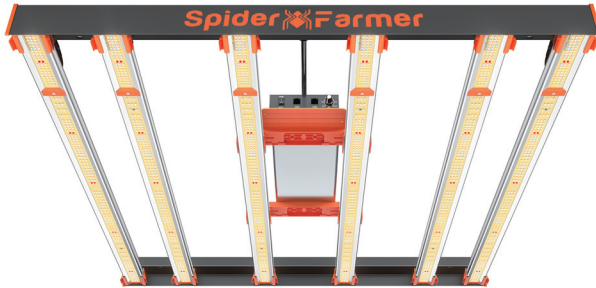

Height: 8"

4(Ft)	3.14	548	588	599	602	590	551	312
3.5	516	1250	1401	1450	1454	1402	1143	518
3.0	536	1130	1320	1371	1372	1323	1128	529
2.5	510	1155	1327	1381	1378	1323	1152	525
2.0	512	1149	1326	1378	1384	1328	1156	515
1.5	527	1127	1324	1376	1369	1318	1125	532
1.0	522	1255	1406	1446	1447	1411	1250	523
0.5	317	557	587	587	574	582	552	312
0.0	0.0	0.5	1.0	1.5	2.0	2.5	3.0	3.5
	4(Ft)							

Height: 10"

4(Ft)	393	559	698	702	699	696	558	395
3.5	554	998	1205	1244	1238	1203	994	551
3.0	568	1033	1240	1304	1307	1237	1025	567
2.5	580	1019	1226	1288	1286	1223	1017	582
2.0	583	1021	1221	1283	1285	1219	1023	582
1.5	586	1029	1243	1309	1306	1238	1032	567
1.0	559	993	1209	1239	1241	1206	995	557
0.5	392	555	699	700	704	700	559	391
0.0	0.0	0.5	1.0	1.5	2.0	2.5	3.0	3.5
	4(Ft)							

Specifications

Spectrum: 660-665nm,2800-3200K,4800-5000K

LED: SAMSUNG LM301B

PPF: 1368umol/S

PPE: 2.75umol/J

Commercial Coverag: 3x3 FT

Personal Coverage: 4x4 FT

Light Dimensions: 33.86"x33.86"x3.54"

Input Voltage: AC100-277V

Operating Temperature: -20-35 C

Power Draw: 480W±5%@AC120-277V

Lifespan: 100000H

2.75 Efficacy
umol/j



5 Warranty
Years

FULL SPECTRUM

SE7000 730W

LED GROW LIGHT

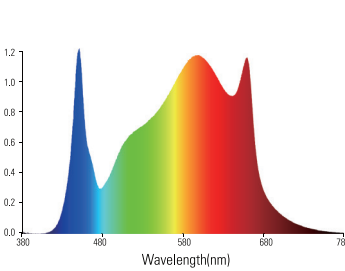
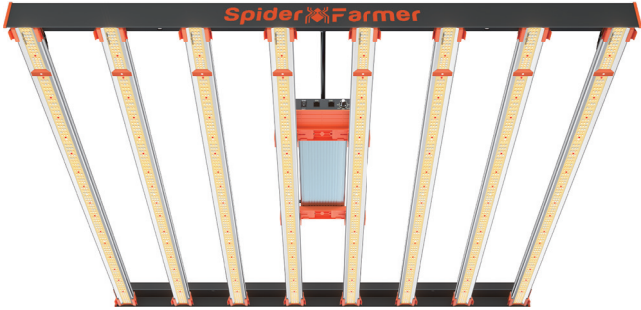

Height: 8" Test in a 4x4ft(120x120cm) tent

1030	1211	1261	1315	1313	1260	1208	1029
1127	1321	1371	1435	1428	1365	1313	1133
1145	1371	1427	1492	1488	1428	1365	1155
1230	1420	1491	1577	1575	1495	1418	1239
1235	1417	1485	1580	1576	1492	1412	1240
1143	1355	1430	1487	1491	1432	1361	1156
1130	1317	1360	1420	1422	1341	1308	1136
1020	1197	1240	1307	1302	1242	1201	1034

Height: 8" Test in a 5x5ft(150x150cm) tent

958	1120	1183	1212	1215	1182	1123	953
1079	1232	1342	1393	1391	1344	1290	1077
1144	1338	1408	1460	1463	1406	1339	1147
1164	1373	1464	1527	1524	1463	1375	1163
1163	1378	1461	1522	1526	1466	1377	1160
1145	1338	1409	1465	1461	1404	1337	1148
1076	1291	1343	1394	1395	1343	1283	1074
954	1126	1178	1218	1214	1180	1124	957

Specifications

Spectrum: 660-665nm,2800-3200K,4800-5000K

LED: SAMSUNG LM301B

PPF: 2044umol/S

PPE: 2.8umol/J

Commercial Coverage: 4x4 FT

Personal Coverage: 5x5 FT

Light Dimensions: 45.31"x45.31"x3.03"

Input Voltage: AC100-277V

Operating Temperature: -20-35 C

Power Draw: 730W±5%@AC120-277V

Lifespan: 100000H

2.8 Efficacy
umol/J



5 Warranty
Years

FULL SPECTRUM

SE8600 860W

LED GROW LIGHT

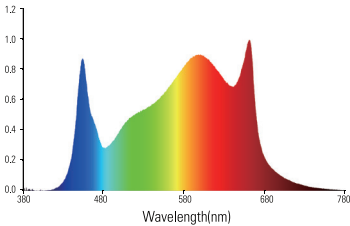
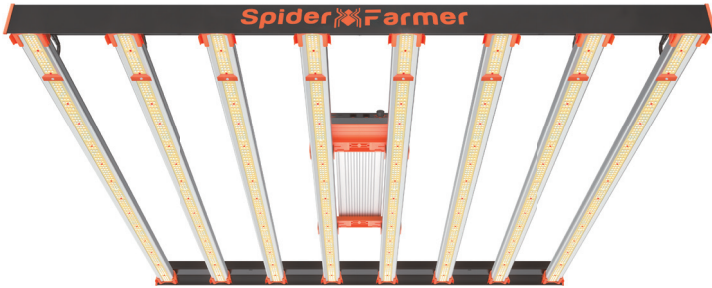

Height: 12" Test in a 4x4ft(120x120cm) tent

4(Ft)	1230	1347	1406	1415	1412	1404	1345	1229
3.5	1316	1456	1521	1539	1536	1520	1455	1318
3.0	1367	1505	1565	1577	1574	1563	1503	1366
2.5	1418	1552	1593	1608	1603	1592	1551	1420
2.0	1423	1549	1590	1600	1606	1587	1556	1425
1.5	1365	1506	1566	1576	1569	1561	1508	1364
1.0	1320	1454	1523	1540	1535	1515	1453	1321
0.5	1231	1347	1401	1410	1421	1410	1348	1227
0.0								

0.0 0.5 1.0 1.5 2.0 2.5 3.0 3.5 4(Ft)

Height: 12" Test in a 5x5ft(150x150cm) tent

4(Ft)	968	1116	1186	1194	1197	1185	1119	963
3.5	1033	1277	1356	1398	1396	1358	1275	1031
3.0	1173	1371	1446	1468	1471	1444	1372	1176
2.5	1168	1416	1490	1512	1509	1489	1418	1167
2.0	1169	1421	1487	1507	1511	1492	1420	1164
1.5	1174	1371	1447	1473	1469	1442	1370	1177
1.0	1030	1276	1357	1399	1400	1357	1278	1028
0.5	964	1122	1182	1200	1196	1183	1120	967
0.0								

0.0 0.5 1.0 1.5 2.0 2.5 3.0 3.5 4(Ft)

Specifications

Spectrum: 660-665nm,2800-3200K,4800-5000K

LED: SAMSUNG LM301B

PPF: 2420umol/S

PPE: 2.8 umol/J

Commercial Coverage: 4 x 4 FT

Personal Coverage: 5 x 5 FT

Light Size: 45.31"x 45.31"x3.74"

Input Voltage: AC100-277V

Operating Temperature: -20-35 C

Power draw: 860W±5%@AC120-277V

Lifespan: 100000H

2.8 umol/J Efficacy



5 Years Warranty

FULL SPECTRUM

SE1000W

LED GROW LIGHT

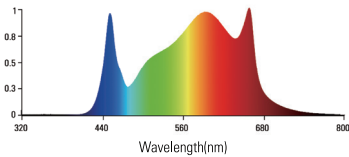
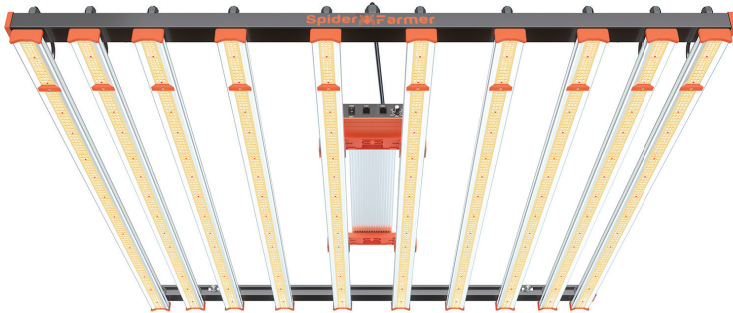

Height: 12" Test in a 4x4ft(120x120cm) tent

4.0FT	1832	2078	2067	2013	2010	2065	2076	1831
3.5	1849	2071	2052	2118	2115	2051	2070	1851
3.0	1807	1999	2070	2103	2100	2068	1997	1806
2.5	1734	1907	2073	2110	2105	2072	1906	1736
2.0	1739	1904	2070	2102	2108	2067	1911	1741
1.5	1805	2000	2071	2102	2095	2066	2002	1804
1.0	1853	2069	2054	2119	2114	2046	2068	1854
0.5	1833	2078	2062	2008	2019	2071	2079	1829
0.0								

Height: 12" Test in a 5x5ft(150x150cm) tent

4.0FT	1414	1706	1793	1836	1839	1792	1709	1409
3.5	1506	1878	1964	1969	1967	1966	1876	1504
3.0	1522	1834	1955	1994	1997	1953	1835	1525
2.5	1417	1773	1889	1995	1992	1888	1775	1416
2.0	1418	1778	1886	1990	1994	1891	1777	1413
1.5	1523	1834	1956	1999	1995	1951	1833	1526
1.0	1503	1877	1965	1970	1971	1965	1879	1501
0.5	1410	1712	1789	1842	1838	1790	1710	1413
0.0								

Specifications

Spectrum: 660nm,3200-4200K,4800-5000K

LED: SAMSUNG LM301B

PPF: 2788umol/S

PPE: 2.9 umol/J

Commercial Coverage: 4 x 4 FT

Personal Coverage: 5 x 5 FT

Light Size: 45.31" x 45.31" x 3.03"

Input Voltage: AC100-277V

Operating Temperature: -20-35 C

Power draw: 1000W±5%@AC100-277V









Lifespan: 100000H

2.9
umol/J Efficacy



5
Years Warranty

PACKAGE INCLUDES

									
	Dimmer Box	LED Driver	Power Cord	Hanging Kits	YOYO	Daisy Chain Cable	Screw	Bracket Legs	Driver Hanger
SE3000	1	1	1	2	2	1	4	4	0
SE4500	1	1	1	0	4	1	4	4	0
SE5000	1	1	1	0	4	1	4	4	0
SE7000	1	1	1	0	4	1	0	4	2
SE8600	1	1	1	0	4	1	0	4	2
SE1000W	1	1	1	0	4	1	0	4	2

INSTALLATION REQUIREMENTS AND PRECAUTIONS

- Please read the manual thoroughly before attempting to install or operate your Spider Farmer Grow Light and keep it for future reference.
- Only connect the light to power sources of the appropriate voltage using the plug received. Protect power cables from being pinched or damaged, especially where the power cable enters the power outlet and the unit.
- If the provided plug does not fit your socket, please contact us for help by email immediately. Please do not replace the power cord or plug by yourself, otherwise we are not responsible for man-made damages.
- Spider farmer grow light can be used in many indoor situations. Suitable hanging methods should be adopted according to the specific situation.
- When hanging and using the light, please strictly follow the installation / assembly steps, and do not exceed the maximum number of lights.
- When installing the light, appropriate positions should be selected to place or hang the light. When hanging the light, specify designed lifting ropes and hooks must be used to ensure that the weight of light is within the weight range borne by the suspended objects.
- When installing the light ensure that there are no inflammable and explosives within a distance of 20 inches.
- Please use professional personnel to install the light. Any improper installation may cause personal injury or material damage.
- Prevent others from entering under the work area. use a suitable. stable and safe platform when installing or maintaining the light.
- The system should only be cleaned as directed in the manual. You should seek service by qualified service personnel if any of the following occur:
 1. The power-supply cord or the plug has been damaged.
 2. The unit has been exposed to rain.
 3. The unit exhibits a marked change in performance.
 4. The unit has been dropped, or its enclosure or chassis is damaged.

INSTALLATION

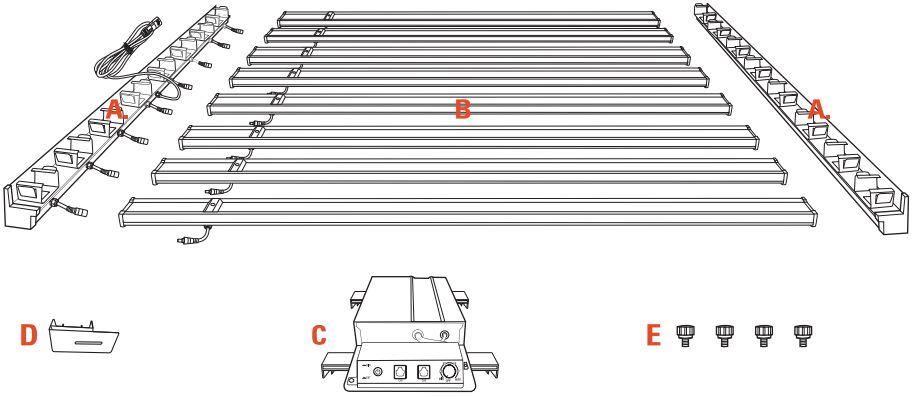

Parts Include:

A.Frame **B.** LED Bar **C.** Driver **D.** Bracket Legs x4 **E.** White Screws (SE3000,SE5000)

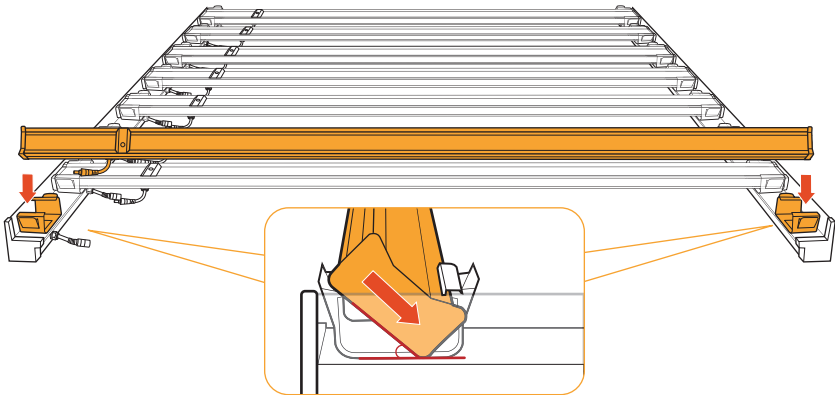

Step 1:

1. Lay down the frames(A)
2. Clip both ends of the the LED bar obliquely into the frame(A) one by one

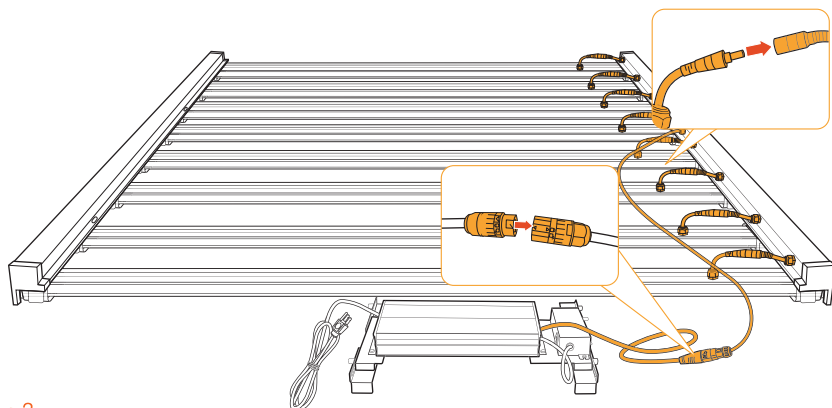

Step 2:

Flip the light with diodes facing down, connect(tighten) the wires of each LED bar, connect(tighten) the wire of the driver.

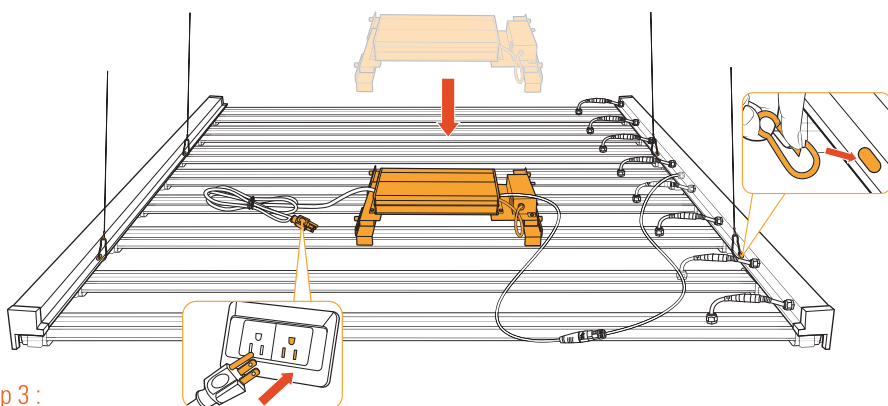

Step 3 :

Hang the driver

1. Fix the driver on the light

*SE3000, SE5000

Adjust the scales of the 4 bracket legs(D) according to the spacing of the light bars, then slide the bracket legs into the desired place, tighten up the 4 white screws(E) underneath the driver bracket to fix the bracket legs, mount the driver on the light.

*SE7000, SE1000W,

Adjust the scales of the 4 bracket legs(D) according to the spacing of the light bars, then slide the bracket legs into the desired place, mount the driver on the light.

2. If you don't need to fix the driver on the light, you could directly plug and use.

Step 4 :

Connect with adjustable rope ratchets. Hang the light above the plants at appropriate height. Plug the power cord to the socket, turn on the light switch.

USER TIPS

STARTER GUIDE

- The rate of photosynthesis and transpiration are directly affected by temperature, humidity and air flow.
- The perfect temperature and humidity for your plants are usually found between -4 F-95 F and 50%-70% humidity, with plenty of airflow to replenish CO2 and a PH of around 6-6.5.
- You may add more calcium and magnesium than is normally needed.

SE Series Hanging Recommendations

Veg:	Flower:
Room Temperature $\leq 28^{\circ}\text{C}$ (82.4 $^{\circ}\text{F}$): Hang at 8"	Room Temperature $\leq 28^{\circ}\text{C}$ (82.4 $^{\circ}\text{F}$): Hang at 6"
Room Temperature $\geq 28^{\circ}\text{C}$ (82.4 $^{\circ}\text{F}$): Hang at 12"	Room Temperature $\geq 28^{\circ}\text{C}$ (82.4 $^{\circ}\text{F}$): Hang at 8"

Tips: When adjusting to the recommended height, make sure your indoor temperature is within the recommended range

Recommended Dimming For SE Series:

Seeding 40%-60%, Veg 60%-90%, Flower 90%-100%

SINGLE LIGHT DIMMING OPERATION

Step1.

Turn on the DIM switch

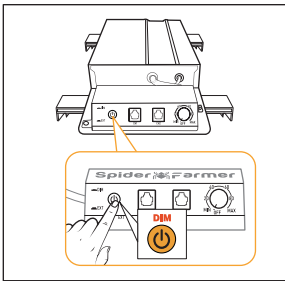

Step2.

Turn the dimmer knob to "MIN"

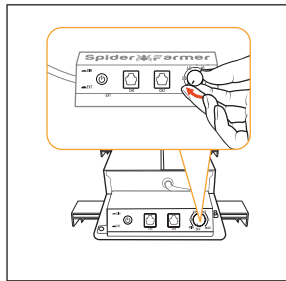

Step3.

Adjust light intensity

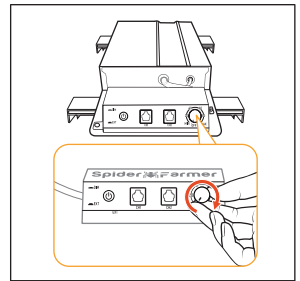

- NOTE:** 1. When the dimming switch is set to "EXT", the dimming function will not work, but the light will stay on at 100% brightness.
2. Only when the dimming switch is set to "DIM", the light switch and dimming knob will function.

**TO ENSURE UNIFORM LIGHT DISTRIBUTION, WHEN CONNECTING MORE LIGHTS,
PLEASE ENSURE THAT EACH LIGHT IS MODEL SLOTS TO MODEL SLOTS,
NOT LIGHT BARS TO LIGHT BARS.**

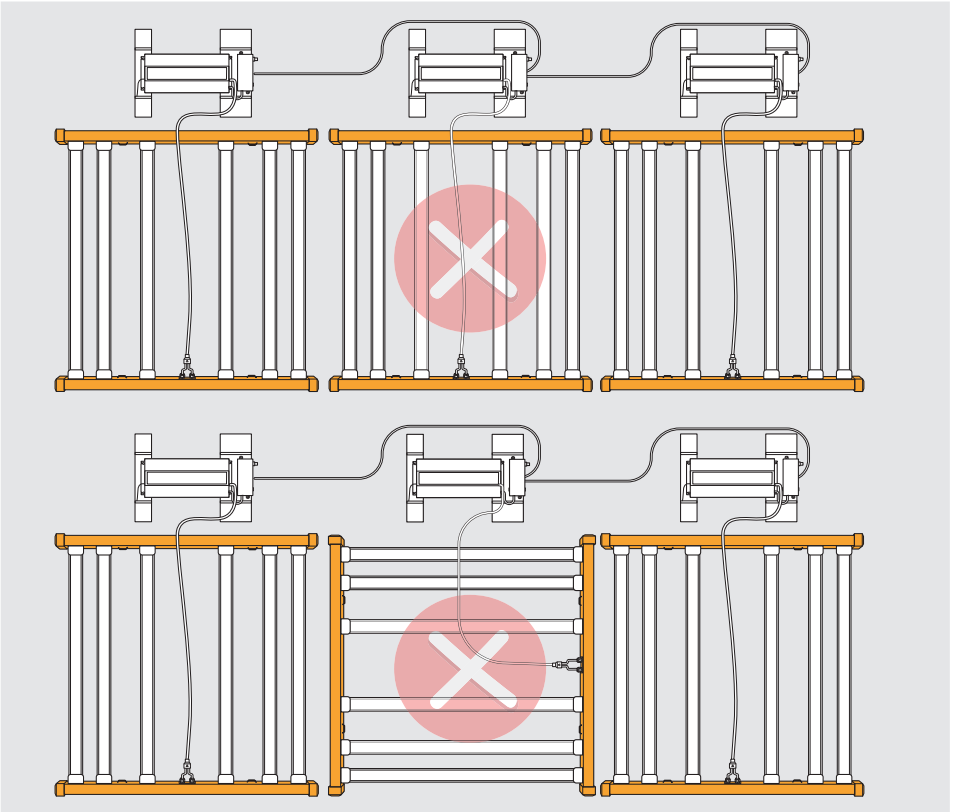
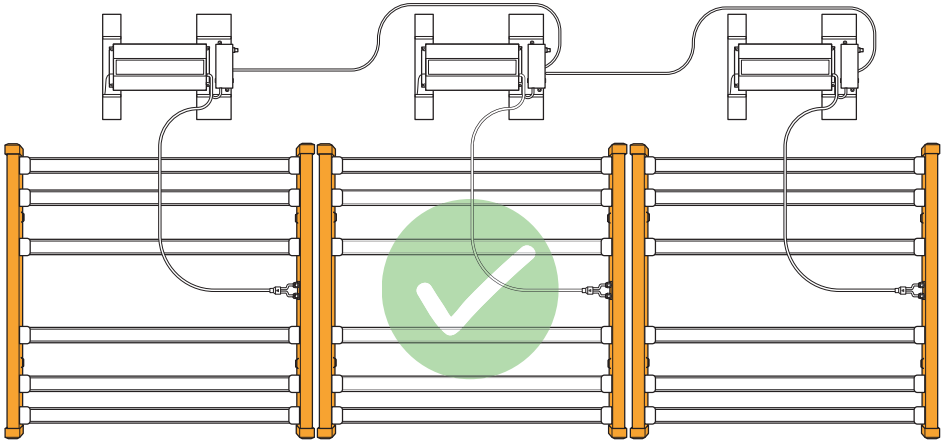

SAFETY INSTRUCTIONS FOR USE

1. The light belongs to class I protection equipment, so the light must be well grounded.
2. The power supply should be connected by professionals.
3. Before use, make sure that the voltage used is not higher or lower than the specified value in the operation manual.
4. For daisy chain operation, the total power cannot exceed the rated power of your timer.
5. Do not touch while in operation
6. Do not look directly into lights without protective glasses
7. Only the plug is allowed to connect the power cord. Please do not pull the power cord with brute force to pull out the plug.
8. Use electricity safely and operate carefully during the installation of light. Avoid touching exposed wires, or you may suffer a fatal electric shock.
9. Unplug power cord on rainy days to help prevent lightning strikes.
10. Please unplug the light when cleaning and repairing
11. Do not disassemble, repair or refit the light without the authorization of the manufacturer or non professionals.
12. The maximum operating temperature is 40 °C . Do not operate the light above this temperature;
13. Do not connect the light to other dimming devices without permission.

WARRANTY

Spider Farmer will provide warranty services through the following options, which are only available in the United States, Canada, United Kingdom, European Union and Australia.

1. You can initiate a return or exchange within 30 days of delivery by providing proof of purchase. Grow tents must be in their original condition. Spider Farmer will bear the shipping cost for return or replacement.
2. If a defect arises within 2 years, Spider Farmer will provide free after-sales service. If a customer returns a product or part that is ineligible for service, Spider Farmer will charge the customer's credit card/PayPal for the authorized amount.
3. LED lights purchased within 2 to 5 years can get free accessories or trade-in allowances.

GENERAL CARE

SPIDER FARMER Grow Lights are passively cooled with zero moving components. They are designed for harsh environments and years of maintenance-free performance. Some basic care will keep your lights working at peak performance cycle-after-cycle.

- Natural convection removes heat away from the heat sink. In order to properly cool itself, at least one inch of space is required between the fixture and the roof of your grow area. Failure to do so may shorten the fixture's lifespan.
- To achieve the optimal lifespan and performance of your fixtures, routinely check for and remove excess dust, debris, and mineral build up from the heat sink and LED array. Cleaning should always be done with the fixture or using low-pressure compressed air while unplugged from its power source.
- Never use a cloth to clean the diode array, otherwise it may scratch or damage the integrity of the silicon seal, or dislodge diodes entirely.
- To limit degradation, avoid touching the diodes with your hands, even in a powered off state.

OTHER CATEGORIES

Grow Tents

Spider Farmer grow tents are designed to create ideal growing conditions for indoor plant cultivation. By adopting a unique 16800 Oxford canvas and Diamond reflective Mylar, Spider Farmer grow tents effectively maximize light reflectivity and prevent light leaks. The metal frame is made from hardened steel, and our tents are three-times thicker and denser than ordinary tents. With a stable metal angle adapter and a load capacity of up to 140 lbs.

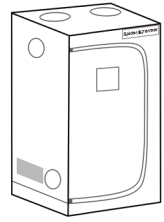

Inline Fan

Utilizing a mixed flow design combined with an EC motor to ensure true energy efficiency with a very low noise level. Lightweight ABS blades reduce the airflow resistance and increase airflow by 40%. The smart controller has multiple modes for operation, 10 speeds, is easy to program and can control the humidity and temperature automatically.

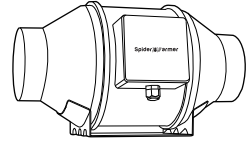

UV LED Grow Light Bar

The SF-UV30 UVA supplemental grow light is designed to provide targeted supplemental blue energy to equal natural sunlight levels to promote overall health, robust plant growth, better flower development and increased production. Each fixture comes with the power supply and everything you need to immediately use, no additional wiring needed and it has a light switch that allows you to control the light easily.

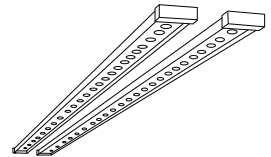

Heat Mat

The Spider Farmer heating mat utilizes its advanced design to quickly heat the root area by 50-77°F (10-25°C) above the ambient air temp within 2 minutes. Compared with the traditional heating wire, the innovative far-infrared film heating speed is faster, the energy consumption is lower, the soft heat distribution is more uniform, and does not consume the moisture in the air, which is more conducive to the germination and rooting of indoor gardening.

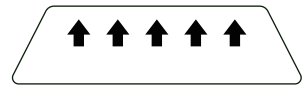

Smart G12 Hydroponics Growing System

The Hydroponic growing system with dimming is ideal for growers to adjust the light intensity according to different growing stages. Allowing for up to 12 plants grow at a time, a visual window so you can see the water level and the growth of plant roots along with drain holes at the bottom of the tank to make drainage easier. The adjustable pump can adjust the water volume of the pump at any time. It is suitable for planting most herb plants, vegetables, fruits, flowers, including lettuce, basil, pepper, tomato and strawberry plants.

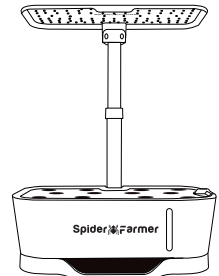

EINBAUVORAUSSETZUNGEN UND VORSICHTSMAßNAHMEN

- Bitte lesen Sie die Gebrauchsanweisung gründlich, bevor Sie versuchen, ein Spider Farm Grow Light einzubauen und zu verwenden, und verwahren Sie sie für zukünftige Lektüre.
- Verbinden Sie die Leuchte nur mit Stromquellen mit der für den mitgelieferten Stecker geeigneten Stromleistung. Schützen Sie Stromkabel vor Quetschungen und Schäden, insbesondere in der Nähe der Stromquelle und des Gerätes.
- Wenn der mitgelieferte Stecker nicht in Ihre Steckdose passt, kontaktieren Sie uns bitte sofort per E-Mail. Ersetzen Sie keinesfalls selbst das Stromkabel oder den Stecker; andernfalls sind wir für jegliche verursachten Schäden nicht verantwortlich.
- Das Spider Farmer Grow Light kann in vielen Situationen in Innenräumen verwendet werden und verschiedene Montagemethoden sind je nach Umgebung möglich.
- Beim Montieren und Verwenden der Leuchte, folgen Sie stets den Anweisungen / Aufbauschritten und überschreiten Sie nicht die maximale Anzahl an Lampen.
- Beim Einbau suchen Sie sich geeignete Stellen aus, an denen Sie die Leuchte platzieren oder montieren können. Beim Aufhängen benötigen Sie spezielle Utensilien wie Hebesaile und Haken, um zu versichern, dass das Gewicht der Leuchte die Traglast der Aufhängung nicht überschreitet.
- Beim Einbau der Leuchte sollten Sie sicherstellen, dass sich innerhalb von 50 Zentimetern keine brennbaren oder explosiven Materialien befinden.
- Bitte holen Sie sich zum Einbau der Leuchte professionelle Hilfe hinzu. Ein fehlerhafter Einbau kann zu Verletzungen oder Materialschäden führen.
- Halten Sie andere Personen davon ab, den Arbeitsbereich zu betreten. Verwenden Sie beim Einbau oder bei der Wartung der Lampen eine stabile und sichere Plattform.
- Das System sollte nur wie in der Gebrauchsanweisung beschrieben gereinigt werden. Sollte einer der folgenden Punkte eintreten, holen Sie eine qualifizierte Fachperson hinzu
 1. Das Stromkabel oder der Stecker wurden beschädigt.
 2. Das Gerät wurde Regen ausgesetzt.
 3. Das Gerät erzielt nicht mehr die korrekte Leistung.
 4. Das Gerät ist heruntergefallen oder der Rahmen oder das Gehäuse wurden beschädigt.

SICHERHEITSHINWEISE FÜR DEN GEBRAUCH

1. Die Lampe gehört zu den Schutzgeräten der Klasse I, daher muss sie gut geerdet sein.
2. Der Anschluss der Stromversorgung sollte von Fachleuten vorgenommen werden.
3. Vergewissern Sie sich vor dem Gebrauch, dass die verwendete Spannung nicht höher oder niedriger ist als der in der Gebrauchsanweisung angegebene Wert.
4. Beim Verkettungsbetrieb darf die Gesamtleistung die Nennleistung der Zeitschaltuhr nicht überschreiten.
5. Während des Betriebs nicht berühren.
6. Nicht ohne Schutzbrille direkt ins Licht schauen.
7. Nur der Stecker darf mit dem Netzkabel verbunden werden. Bitte ziehen Sie nicht mit roher Gewalt am Netzkabel, um den Stecker herauszuziehen.
8. Gehen Sie sicher mit Strom um und seien Sie bei der Installation der Leuchte vorsichtig. Vermeiden Sie es, freiliegende Drähte zu berühren, da Sie sonst einen tödlichen Stromschlag erleiden könnten.
9. Ziehen Sie an regnerischen Tagen den Netzstecker, um Blitzschläge zu vermeiden.
10. Trennen Sie beim Reinigen die Stromversorgung.
11. Die Leuchte darf nicht ohne Genehmigung des Herstellers oder von Laien demontiert, repariert oder umgebaut werden.
12. Die maximale Betriebstemperatur beträgt 40 C. . Betreiben Sie die Leuchte nicht über dieser Temperatur.
13. Schließen Sie die Leuchte nicht unerlaubt an andere Dimmgeräte an.

GARANTIE

Spider Farmer bietet Garantieleistungen über die folgenden Optionen an, die nur in den USA verfügbar sind:

Kanada, Vereinigtes Königreich, Europäische Union und Australien.

1. Für jedes Produkt muss der Verbraucher einen Kaufbeleg vorlegen, der Erhalt der Ware kann kein Grund zur Rückgabe und zum Umtausch innerhalb von 30 Tagen sein. Growzelte müssen im Originalzustand sein. Spider Farmer trägt die Versandkosten für die Rücksendung oder den Ersatz.
2. Wenn innerhalb von 2 Jahren ein Defekt auftritt, bietet Spider Farmer einen kostenlosen Kundendienst. Wenn der Kunde ein Produkt oder Teil zurücksendet, das für den Service nicht in Frage kommt, wird Spider Farmer die Kreditkarte/Paypal des Kunden mit dem autorisierten Betrag belasten.
3. Die für 2 bis 5 Jahre gekauften LED-Leuchten können kostenloses Zubehör oder eine Inzahlungnahme erhalten.

FRANÇAIS

PRÉCAUTIONS ET PRÉ-REQUIS D'INSTALLATION

- Merci de lire attentivement ce manuel avant d'essayer de monter ou de faire fonctionner l'éclairage de croissance Spider Farmer et de le conserver pour référence ultérieure.
- Ne connectez la lumière qu'aux sources d'alimentation ayant la tension appropriée et en utilisant la prise fournie. Protégez les câbles d'alimentation pour éviter qu'ils ne soient pliés ou endommagés, en particulier aux endroits où le câble entre dans la prise et dans l'appareil.
- Dans le cas où la fiche fournie serait incompatible avec votre prise, merci de nous contacter immédiatement par e-mail pour obtenir de l'aide. Merci de ne pas remplacer le câble d'alimentation ou la fiche vous-même, autrement nous ne serons pas responsables des dommages causés par l'homme.
- La lampe de culture Spider farmer peut servir en intérieur à de nombreuses applications, et les méthodes de montages peuvent être adaptées en fonction de leur endroit d'installation.
- Pour accrocher et utiliser la lampe, veuillez respecter strictement les étapes d'installation et d'assemblage et ne pas dépasser le nombre maximal de lampes.
- Lors de l'installation de la lumière, des endroits appropriés doivent être choisis pour installer ou suspendre la lumière. Au moment de monter la lumière, il convient d'utiliser des câbles de levage et des crochets spécialisés afin de s'assurer que le poids de la lumière est compris dans la plage de poids supportée par les objets suspendus.
- Lors de l'installation de la lampe, assurez-vous qu'il n'y a pas de produits inflammables ou explosifs dans un rayon de 50 cm.
- Merci de faire appel à du personnel professionnel pour installer la lumière. Toute erreur de montage peut entraîner des blessures ou des dommages matériels.
- Évitez que d'autres personnes ne pénétrèrent sous la zone de travail, utilisez une plate-forme appropriée, stable et sûre lors de l'installation ou de l'entretien de la lumière.
- Le nettoyage du système doit se faire uniquement selon les instructions du manuel. Vous devez faire appel à un personnel de service qualifié si l'un des cas suivants se produit
 1. Le câble d'alimentation ou la fiche ont été endommagés.
 2. L'appareil a été exposé à la pluie.
 3. L'appareil présente un changement marqué de ses performances.
 4. L'appareil est tombé, ou son boîtier ou son châssis est endommagé.

INSTRUCTIONS DE SÉCURITÉ LORS DE L'UTILISATION

1. La lampe est considérée comme un équipement de protection de classe I, il faut donc qu'elle soit bien mise à la terre.
2. Le branchement de l'alimentation secteur doit être effectué par des professionnels.
3. Avant toute utilisation, vérifiez que la tension utilisée n'est pas supérieure ou inférieure à la valeur spécifiée dans le manuel d'utilisation.

4. Pour une utilisation en cascade, la puissance totale ne peut pas dépasser la puissance nominale de votre minuterie.
5. Ne pas toucher pendant le fonctionnement.
6. Ne pas regarder directement les lumières sans lunettes de protection
7. Seule la prise peut être utilisée pour connecter le câble d'alimentation. Attention de ne pas tirer dessus trop brutalement en retirant la fiche.
8. Soyez prudent dans l'utilisation de l'électricité et opérez avec précaution pendant l'installation de la lumière. Ne touchez pas les fils exposés, sinon vous risquez de subir un choc électrique mortel.
9. Débranchez le câble d'alimentation les jours de pluie pour éviter la foudre.
10. Veuillez débrancher la lumière lors du nettoyage et de la réparation.
11. Ne désassemblez pas, ne réparez pas ou ne remontez pas la lumière sans l'autorisation du fabricant ou de non professionnels.
12. Les températures maximales de fonctionnement sont de 40 C. Ne pas utiliser la lumière au-dessus de cette température ;
13. Ne branchez pas la lumière à d'autres dispositifs de variations sans autorisation.

GARANTIE

Spider Farmer fournira un service de garantie via les options suivantes, qui ne sont disponibles qu'aux États-Unis, Canada, Royaume-Uni, Union européenne et Australie.

1. Chaque produit nécessite que le consommateur fournisse une preuve d'achat, la réception des marchandises ne peut donner lieu à aucun motif de retour et d'échange dans les 30 jours. Les tentes de culture doivent être dans leur état d'origine. Spider Farmer prendra en charge les frais d'expédition pour le retour ou le remplacement.
2. Si un défaut survient dans les 2 ans, Spider Farmer fournira un service après-vente gratuit. Si le client retourne un produit ou une pièce qui n'est pas éligible au service, Spider Farmer débitera la carte de crédit/paypal du client pour le montant autorisé.
3. Les lumières LED achetées pendant 2 à 5 ans peuvent obtenir des accessoires gratuits ou une allocation de reprise.

ITALIANO

REQUISITI E PRECAUZIONI PER L'INSTALLAZIONE

- Leggi attentamente il manuale prima di tentare di installare o utilizzare la lampada per la crescita dei ragni e conservalo per future consultazioni.
- Collega la lampada solo alle fonti di alimentazione con il voltaggio appropriato utilizzando la spina ricevuta. Proteggi i cavi di alimentazione da schiacciamenti o danni, soprattutto nel punto in cui il cavo di alimentazione entra nella presa di corrente e nell'unità.
- Se la spina fornita non è adatta alla tua presa di corrente, contattaci immediatamente per ricevere assistenza via e-mail. Non sostituire il cavo di alimentazione o la spina da solo, altrimenti non siamo responsabili per i danni provocati da terzi.
- La luce di coltivazione per ragni può essere utilizzata in molte occasioni al chiuso e si possono adottare i metodi di sospensione più adatti in base al luogo in cui ci si trova.
- Quando appendi e utilizzi la luce, segui scrupolosamente le fasi di installazione/montaggio e non superare il numero massimo di luci.
- Quando si installa la luce, è necessario scegliere le posizioni appropriate per posizionare o appendere la luce. Quando si appende la luce, è necessario utilizzare corde e ganci di sollevamento appositamente attrezzati per garantire che il peso della luce rientri nel range di peso sopportato dagli oggetti sospesi.
- Quando si installa la lampada, è necessario assicurarsi che non vi siano sostanze infiammabili ed esplosive entro una distanza di 20 pollici.
- Rivolgiti a personale professionale per l'installazione della lampada. Qualsiasi installazione non corretta può causare lesioni personali o danni materiali.
- Impedisci ad altri di entrare nell'area di lavoro, utilizza una piattaforma adeguata, stabile e sicura durante l'installazione o la manutenzione della lampada.
- Il sistema deve essere pulito solo come indicato nel manuale. È necessario rivolgersi a personale di assistenza qualificato se si verifica uno dei seguenti casi
 1. Il cavo di alimentazione o la spina sono stati danneggiati.

2. L'unità è stata esposta alla pioggia.
3. L'unità presenta una marcata variazione delle prestazioni.
4. L'unità è caduta o l'involucro o il telaio sono danneggiati.

ISTRUZIONI DI SICUREZZA PER L'USO

1. La lampada appartiene ai dispositivi di protezione di classe I, quindi deve essere ben collegata a terra.
2. L'alimentazione deve essere collegata da professionisti.
3. Prima dell'uso, assicurati che la tensione utilizzata non sia superiore o inferiore al valore specificato nel manuale operativo.
4. Per il funzionamento a margherita, la potenza totale non può superare la potenza nominale del timer.
5. Non toccare il timer mentre è in funzione.
6. Non guardare direttamente le luci senza occhiali protettivi
7. Il cavo di alimentazione può essere collegato solo alla spina. Non tirare il cavo di alimentazione con la forza bruta per estrarre la spina.
8. Usa l'elettricità in modo sicuro e opera con attenzione durante l'installazione della luce. Evita di toccare i fili scoperti, altrimenti potresti subire una scossa elettrica fatale.
9. Scollega il cavo di alimentazione nei giorni di pioggia per evitare di essere colpito da fulmini.
10. Scollegare la lampada durante le operazioni di pulizia e riparazione.
11. Non smontare, riparare o rimontare la lampada senza l'autorizzazione del produttore o di personale non professionista.
12. La temperatura massima di funzionamento è di 40 C. Non utilizzare la lampada al di sopra di questa temperatura;
13. Non collegare la lampada ad altri dispositivi di oscuramento senza autorizzazione.

GARANZIA

Spider Farmer fornirà il servizio di garanzia attraverso le seguenti opzioni, disponibili solo negli Stati Uniti, Canada, Regno Unito, Unione Europea e Australia.

1. Ogni prodotto richiede al consumatore di fornire una prova d'acquisto, il ricevimento della merce non può essere motivo di restituzione e cambio entro 30 giorni. Le tende Grow devono essere nelle condizioni originali. Spider Farmer sosterrà il costo di spedizione per la restituzione o la sostituzione.
2. Se si verifica un difetto entro 2 anni, Spider Farmer fornirà un servizio post-vendita gratuito. Se il cliente restituisce un Prodotto una parte non idonea al servizio, Spider Farmer addebiterà l'importo autorizzato sulla carta di credito/paypal del cliente.
3. Le luci a LED acquistate per un periodo compreso tra 2 e 5 anni possono ricevere accessori gratuiti o indennità di permuta.

ESPAÑOL

REQUISITOS Y PRECAUCIONES DE INSTALACIÓN

- Recomendamos leer el manual detenidamente antes de intentar instalar o utilizar la luz de cultivo Spider Farmer Grow Light y que lo guarde para futuras consultas.
- Conecte la luz sólo a las fuentes de alimentación del voltaje adecuado utilizando el enchufe que viene de fábrica. Proteja los cables de alimentación para que no se pellizquen ni se dañen, especialmente en el lugar donde el cable entra en la toma de corriente y en la unidad.
- Si el enchufe suministrado no se ajusta a su toma de corriente, comuníquese con nosotros por correo electrónico inmediatamente. No sustituya el cable de alimentación o el enchufe por su cuenta, de lo contrario no nos hacemos responsables de los daños causados por el hombre.
- La luz de cultivo Spider Farmer puede utilizarse en muchas ocasiones en interiores, y se pueden adoptar métodos de colgado adecuados según el lugar.
- Al colgar y utilizar la luz, siga estrictamente los pasos de instalación/montaje y no exceda el número máximo de luces.
- Al instalar la luz, se seleccionarán las posiciones adecuadas para colocar o colgar la luz. Cuando se cuelgue la luz, deberán utilizarse cuerdas y ganchos de elevación especialmente equipados para garantizar que el peso de la luz esté dentro del rango de peso soportado por los objetos suspendidos.

- Cuando se instala, debe asegurarse que no hay inflamables ni explosivos a una distancia de 50 cm.
- Asegúrese que un profesional se encarga de instalar la luz. Cualquier instalación incorrecta puede causar daños personales o materiales.
- Evite que otras personas entren bajo el área de trabajo, utilice una plataforma adecuada, estable y segura cuando instale o mantenga la luz.
- El sistema sólo debe limpiarse como se indica en el manual. Deberá acudir a personal de servicio cualificado si se produce cualquiera de las siguientes situaciones
 1. El cable de alimentación o el enchufe están dañados.
 2. La unidad ha estado expuesta a la lluvia.
 3. La unidad muestra un marcado cambio en el rendimiento.
 4. La unidad se ha caído, o su carcasa o chasis están dañados.

INSTRUCCIONES DE SEGURIDAD PARA EL USO

1. La luz pertenece a los equipos de protección de clase I, por lo cual debe tener conexión a tierra.
2. El suministro de energía debe ser conectado por profesionales.
3. Antes de utilizarlo, asegúrese de que el voltaje utilizado no es superior o inferior al valor especificado en el manual de instrucciones.
4. Para el funcionamiento en cadena, la potencia total no puede superar la potencia nominal de su programador.
5. No se debe tocar mientras esté en funcionamiento
6. No debe mirar directamente a las luces sin gafas protectoras
7. Sólo se puede conectar el cable de alimentación con el enchufe. No tire del cable de alimentación para sacar el enchufe por medio de la fuerza.
8. Utilice la electricidad de forma segura y opere con cuidado durante la instalación de la luz. Evite tocar los cables expuestos, o puede sufrir una descarga eléctrica fatal.
9. Desenchufe el cable de alimentación durante los días de lluvia para evitar la caída de rayos.
10. Siempre desenchufe la luz cuando necesite limpiar o repararla.
11. No desmonte, repare o vuelva a montar la luz sin autorización del fabricante o profesionales.
12. La temperatura máxima de funcionamiento es de 40°C. La lámpara no debe funcionar a una temperatura superior a esta.
13. No conecte la luz a otros dispositivos de regulación sin permiso.

GARANTÍA

Spider Farmer brindará servicio de garantía a través de las siguientes opciones, que solo están disponibles en los Estados Unidos, Canadá, Reino Unido, Unión Europea y Australia.

1. Cada producto requiere que el consumidor proporcione un comprobante de compra, la recepción de los productos no puede ser motivo para la devolución y el cambio en 30 días. Las tiendas de cultivo deben estar en su estado original. Spider Farmer correrá con los gastos de envío por devolución o reemplazo.
2. Si surge un defecto dentro de los 2 años, Spider Farmer proporcionará un servicio posventa gratuito. Si el cliente devuelve un Producto o pieza que no es elegible para el servicio, Spider Farmer cargará la cantidad autorizada en la tarjeta de crédito/paypal del cliente.
3. Las Luces LED compradas durante 2 a 5 años pueden obtener accesorios gratuitos o una asignación de intercambio.

YOUR RELIABLE INDOOR GROW PARTNER

Our Social Media



Contact:

Tel: +1 866 553 8582

Email: support@spider-farmer.com

info@spider-farmer.com